



XCIENT

NEW THINKING. NEW POSSIBILITIES.

People's expectation toward individual mobility requires more than just a convenient means of transportation. The old understanding of cars has become outdated. A car represents individuals' lifestyles, and it became an integral part of their lives. At the same time, the automobile industry has experienced seismic change. Hyundai Motor Company has grown rapidly to become one of the largest automakers, backed by world class production capability and superior quality. We have now reached a point where we need a qualitative approach to bring bigger ideas and relevant solutions to our customers. This is an opportunity to move forward and we have developed a new brand slogan that encapsulates our willingness to take a big leap. Led by our new slogan and the new thinking underlying it, we will become a company that keeps challenging itself to unlock new possibilities for people and the planet.

Hyundai Motor Company

www.hyundai.com
GEN. LHD 1306 ENG



Copyright © 2013 Hyundai Motor Company. All Rights Reserved.

The most advanced evolution and innovation is presented



XCIENT, the novelty towards the unknown world





The completion of the advanced style

XCIENT cab with higher full height (+225mm) and longer full length (+175mm)
 With the availability of more space, experience more comfort and freedom as you drive.

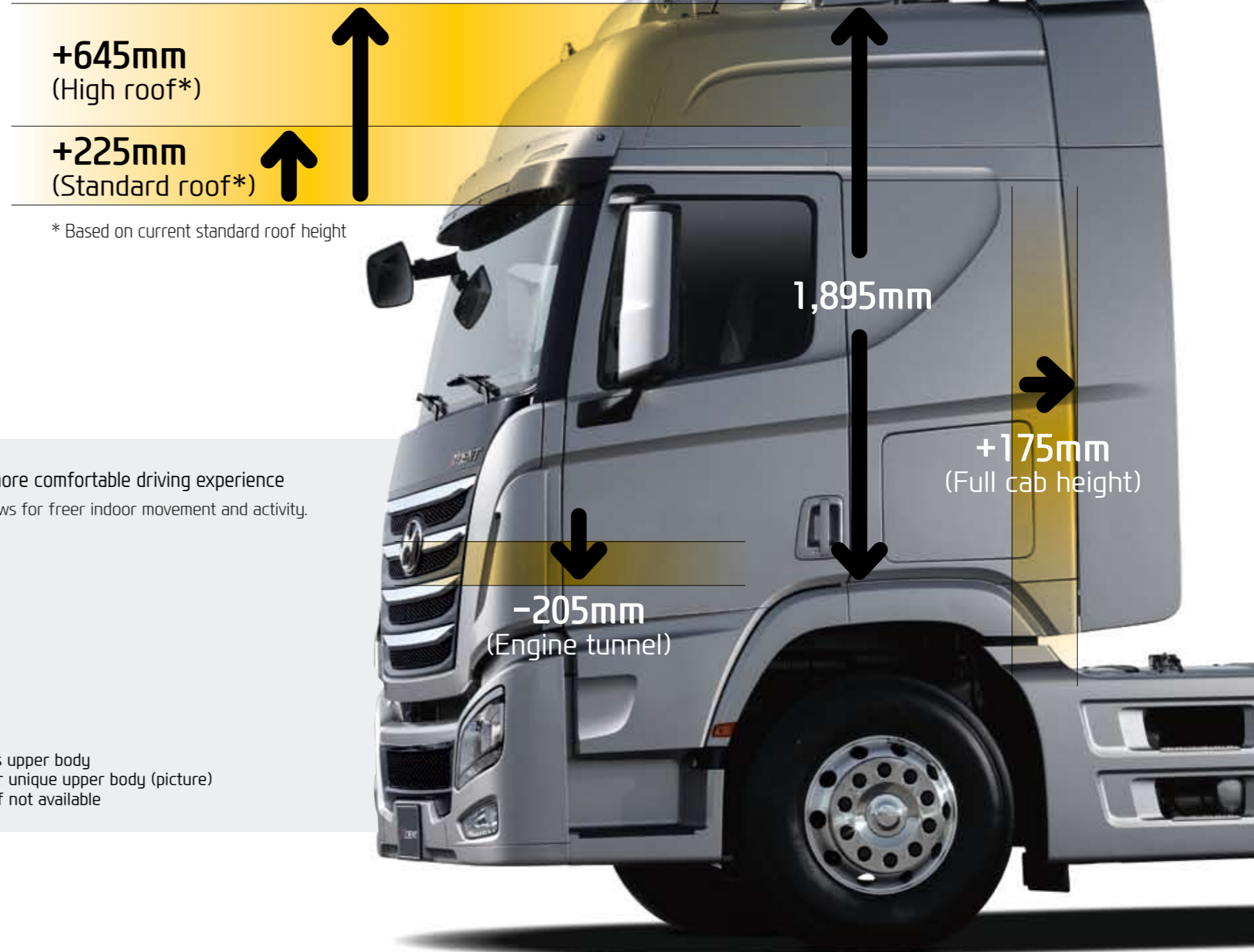
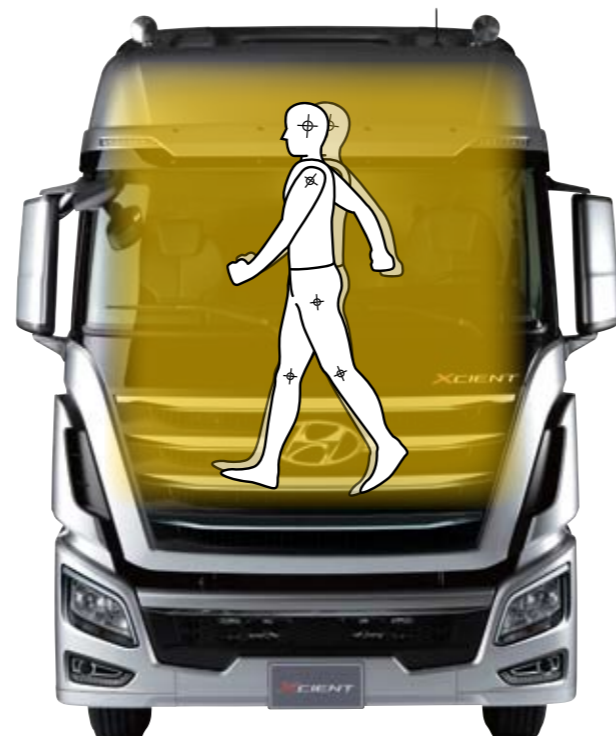

Cabin Variant

Standard Roof		High Roof	Low Roof
Day Cab		Sleeper Cab	
D	S	H	L

D : Day cab / S : Standard cab / H : High roof / L : Low roof

Cabin Space Comparison

Cabin	CURRENT (EG)	XCIENT(QZ)	
		Compared with EG	
Length	2,165	+175	2,340
Width	2,495	-5	2,490
Height	STD	+225	3,230
	High	-	+645
Internal Height	STD	+390	1,490
	High	-	+795
Engine tunnel	395	-205	190
Bed Size	650	+150	800

Unit : mm

Wider space for a more comfortable driving experience
 Its optimum space allows for freer indoor movement and activity.

Tractor : S / H
 Cargo : S
 Dump : D / S / L
 Mixer : S / L

※ Day cab for various upper body
 ※ Low roof option for unique upper body (picture)
 ※ Day cab + Low roof not available

Innovative design

Adopting the aerodynamic style that hasn't been implemented in conventional models, the XCIENT is innovatively designed with the inclination of the windshield, expansion of the front volume, and application of dynamic character lines.



Simple and chic in style

XCIENT integrated the color of side-view mirrors, roof visor, side garnish, mud guard, and other components like that of an existing luxury sedan so as to present a sophisticated sense of identity.



1. Application of corner vane to reduce side contamination
2. Low-drag European mirror
3. Corner vane integrated large front grill and wide bumper
4. Roof visor and roof spoiler with height adjustment

Outside mirrors
For improved visibility, the presence of blind spot is reduced by enlarging the outside mirror and through the design/utilization of aerodynamic mirror, noise as well as water hold-up phenomenon on the side glass is reduced.







The second evolution of *XCIENT*

Largest in its class in terms of **storage space**

Stay worry-free as it takes care of your storage needs wherever you go.



1. Cup holder



2. Cooler and warmer
(World first refrigerant and electric coil method)

3. Overhead console (150 liters)

4. Rear overhead console
(high roof : 320 liters)



Lower crash pad console (16 liters)



Lower bed console (120 liters)



The second evolution of **XCIENT**

The comfort presented by
the world's largest bed



The thoughtful consideration to soothe driver's fatigue after long-hours of driving is reflected in the maximized size of the sheet.

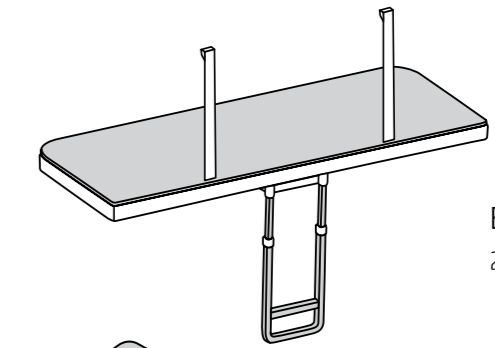

Bed 2nd Floor (high roof only)
2nd floor bed for high roof cabin

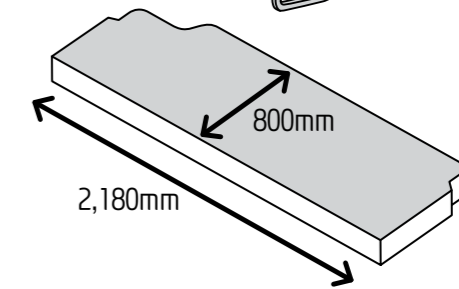

Sleeper Cabin Bed (option)
World best class bed size





The second evolution of **XCIENT**

The smart driving space presented only by XCIENT

A total of about 100 functions including a crash pad with optimally arranged hand-reach switches, audio, multi-display, Bluetooth, hands-free system, cruise switch add comfort to your driving.



1. Multi Display (black color)

Driving information, fault diagnosis, axle weight (air sus.) and etc



2. Q800

(Radio + USB + Aux. + CD + i-pod + Bluetooth)

Passenger Seat (Convenience focused seats)

- Belt-in-seat
- Air suspension (option)
- Folding seat (option)



Backward folding
- Console function

Forward folding
- Seat cushion



New profile seat (Ergonomic new profile seat)

- Cold / warm air ventilation
- Leather covering
- Belt-in-seat
- Seat operating on the bed
- Air suspension (Multi function seat)



The second evolution of *XCIENT*

Experience the truck of the future

ABS with ASR (Anti-Slip Regulator)

This ABS (Anti-Locking Brake System) brings the vehicle to a safe, controlled stop and is particularly advantageous whilst driving under slippery road conditions. The driver can apply maximum pressure on the brake pedal without worrying about wheel lock, skidding and subsequent loss of control. With ABS/ASR, the driver can maintain full directional stability of the vehicle at all times and avoid potentially dangerous situations.

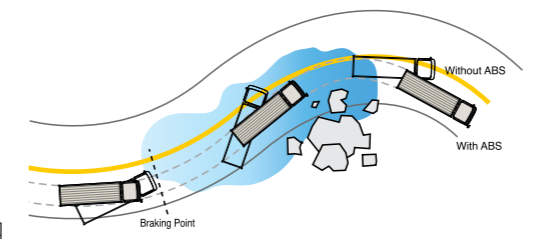

Ergonomic switch operation



Power Window System - Easy window switch control





The third evolution of **XCIENT**

The essence of **high technology**

XCIENT expresses a sense of sophistication both internally and externally as it features metallic pad, new trim colors and pattern, and soft mood light using an LED lamp, an approach that is hardly imagined in other trucks.



Indoor room lamps



head lamp

The third evolution of **XCIENT**

World-class comfort when getting on and off the vehicle

World-class comfort when getting on and off the vehicle is presented through the 105mm lowered stair-type steps, which are the widest in its class.

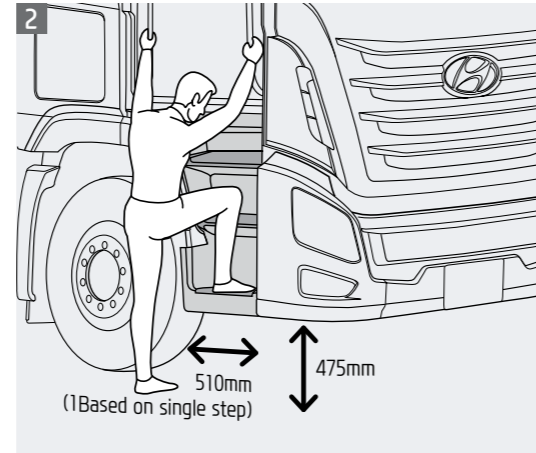

1. Grip for getting on and off the vehicle

2. Inclined steps with the largest cross-sectional area in its class



The third evolution of **XCIENT**

Comfort by being away even from fine vibration

As the first in Korea to use front-wheel air-suspension, XCIENT provides the best riding comfort by lowering the vehicle's vibration frequency from 1.9Hz to 1.1Hz.

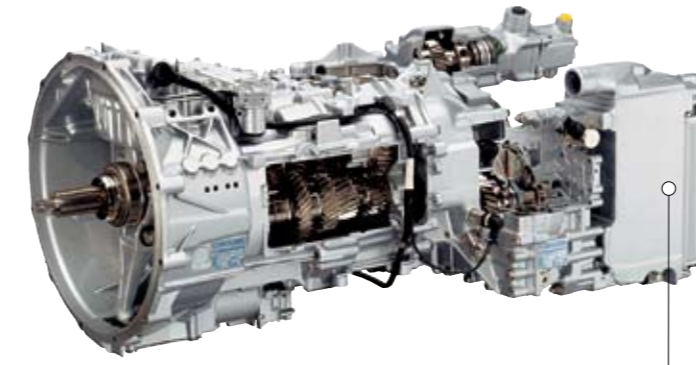

Retarder (Option)

This retarder system not only reduces the maintenance cost of a vehicle but also drastically improves driving safety and brake performance by increasing the life of the brake lining by four times.



Automatic (ECAS) 4-bag type air-suspension



Cab air-floating suspension





Test under 40° below zero in the Arctic (4x2 Tractor)

The fourth evolution of **XCIENT**

Extreme low-temperature testing has been completed

To apply powerful durability as much as possible, Hyundai Xcient has completed extreme low-temperature tests about various driving and durability successfully, and has proved that it is the best truck in the world with strong power and durability as a result.



Driving test at Ivalo, the northmost place in Finland



Improved fuel efficiency Further improvement of profit

With its 7% improved fuel efficiency, XCIENT is guaranteed for maximum practicability and efficiency.



Powertec Engine

D6CC41 (Euro4)
Max. Power : 410ps
Max. Torque : 188kg·m
Displacement : 12.920cc

D6CC3H (Euro4)
Max. Power : 380ps
Max. Torque : 160kg·m
Displacement : 12.920cc

D6CB41 (Euro3)
Max. Power : 410ps
Max. Torque : 188kg·m
Displacement : 12.920cc

D6CA41 (Euro2)
Max. Power : 410ps
Max. Torque : 188kg·m
Displacement : 12.920cc



H Engine

D6HB3H (Euro3)
Max. Power : 380ps
Max. Torque : 173kg·m
Displacement : 9,960cc

D6HB38 (Euro3)
Max. Power : 380ps
Max. Torque : 160kg·m
Displacement : 9,960cc



Q Engine

D6AC (Euro1)
Max. Power : 340ps
Max. Torque : 140kg·m
Displacement : 11,149cc

The reliable and trustworthy **durability**

XCIENT maintains structural durability under any road condition due to its robust design that extensively applied structured cab and high-tensile steel.



Air cleaner



Front frame & High-tensile chassis
The roll forming method was applied to the high-tensile frame and by increasing the length between frames up to 60mm, it ensures driving comfort as well as excellent vehicle handling performance.

Reduces in half the time needed for maintenance **Largest maintenance panel in its class**



Cab tilting

Along with the extensively increased cab tilting angle up to 61°, the volume of the cab tilting cylinder was enlarged. Also, it allows for ease of maintenance by preventing oil leakage with the use of a protection cover on the top part while securing the volume of the tilting pump reservoir.

Bumper-integrated front folding steps

For easier maintenance of more parts compared to the previously applied maintenance panel opening at the front, the broad width folding steps are newly designed.



Quality in Every Detail



Steering wheel (Including pneumatic tilt and telescopic function)



Roll-screen type sun visor (Front: Automatic, Side: Manual)



Overhead console



Rear overhead console (High roof)



Back panel console and bedside console



Bedroom lamp



Air-conditioner (Remote controllable)



Sun-Roof



T.G.S knob



New profile sheet (Driver's seat)



Room lamp



Lower crash pad compartment



Lower bed console

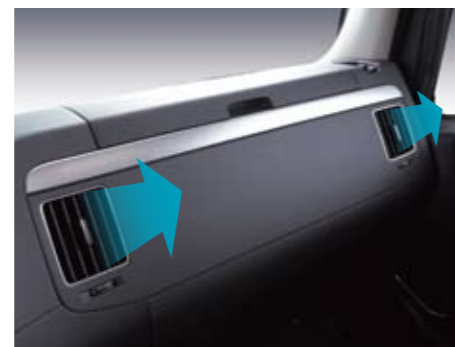

Ion generator (Odor removal and sterilization)



Table at the passenger seat (3-step expandable type)



Pull-down door glass (Application of water-repellent door glass)



External compartment (1,500mm of lowest accessibility on the same level)

XCIENT 4×2 Tractor

Item		4×2 TRT			
		High / Long	High / Medium	Low / Long	
		D6AC	D6HB38	D6CC41	
Dimension (mm)	Overall length	6,435	6,190	6,490	
	Overall width	2,490			
	Overall height (STD / High)	3,260 / 3,845		3,315 / 3,805	
	Wheel Tread	Front	2,060	2,040	
		Rear	1,826	1,826	
	Wheebase	3,900	3,600	3,900	
	Frame Rear Over Hang	995		1,050	
	Ground to Roof (STD / High)	3,220 / 3,635		3,175 / 3,595	
	Ground to frame (topside)	1,080		980	
	Cab to Rear Axle	2,985	2,685	2,985	
Weight (kg)	Kerb Weight	Front	4,965	4,975	5,150
		Rear	2,010	1,905	2,145
		Total	6,975	7,180	7,295
	Axle load	Front	6,500		7,500
		Rear	11,800		13,000
	Permissible Payload	11,325	11,120	13,205	
Permissible GVW	18,300		20,500		
Performance	Min. turning radius (m)	7.1	6.6	7.1	
Frame	Type	Ladder type, Single channel			
	Main Side rail	300×90×8		280×90×8	
Engine	Model	D6AC (Euro1)	D6HB38 (Euro 3)	D6CC41 (Euro 4)	
	Type	Diesel,Turbo intercooler			
	Max.Power	340ps(247kw) @2,200 rpm	380ps(280kw) @2,000 rpm	410ps(302kw) @1,900 rpm	
	Max.Toque	140kgm(1333Nm) @1,400 rpm	160kgm(1568Nm) @1,200 rpm	188kgm(1844Nm) @1,200 rpm	
	No. of cylinder	In line 6 cylinder			
	Bore × Stroke	130×140 (mm)	122×142 (mm)	130×155 (mm)	
	Displacement	11,149 cc	9,960 cc	12,344 cc	
	Controller Type	All Speed type (RLD-J)	Electronic control		
	Air Cleaner	Dry paper elements			

XCIENT 6×4 Tractor

Item		6x4 TRT			
		High / Short	High / Short	High / Medium	
		D6AC	D6HB38	D6CC41	
Dimension (mm)	Overall length	7,010		7,310	
	Overall width	2,490			
	Overall height (STD / High)	3,450 / 3,835			
	Wheel Tread	Front	2,060	2,060	
		Rear	1,825	1,825	
	Wheebase	4,650		4,950	
	Frame Rear Over Hang	820			
	Ground to Roof (STD / High)	3,210 / 3,625			
	Ground to frame (topside)	1,080			
	Cab to Rear Axle	3,060		3,360	
Weight (kg)	Kerb Weight	Front	4,880	4,970	5,225
		Rear	3,600	3,610	3,705
		Total	8,480	8,580	8,930
	Axle load	Front	6,500		
		Rear	25,200		
	Permissible Payload	23,220	23,120	22,770	
Permissible GVW	31,700				
Performance	Min. turning radius (m)	7.2		7.6	
Frame	Type	Ladder type, Single channel			
	Main Side rail	300×90×8			
Engine	Model	D6AC (Euro1)	D6HB38 (Euro 3)	D6CC41 (Euro 4)	
	Type	Diesel, Turbo intercooler			
	Max.Power	340ps(247kw) @2,200 rpm	380ps(280kw) @2,000 rpm	410ps(302kw) @1,900 rpm	
	Max.Toque	140kgm(1333Nm) @1,400 rpm	160kgm(1568Nm) @1,200 rpm	188kgm(1844Nm) @1,200 rpm	
	No. of cylinder	In line 6 cylinder			
	Bore × Stroke	130×140 (mm)	122×142 (mm)	130×155 (mm)	
	Displacement	11,149 cc	9,960 cc	12,344 cc	
	Controller Type	All Speed type (RLD-J)	Electronic control		
	Air Cleaner	Dry paper elements			

Item		4×2 TRT		
		High / Long	High / Medium	Low / Long
		D6AC	D6HB38	D6CC41
Transmission	Model	M12S6	H160S2x5	ZF16S1830
	Type	F6 / R1	F10 / R2	F16 / R2
	1st (Low / High)	6.814	9.153 / 7.145	13.80 / 11.54
	2nd (Low / High)	3.947	4.783 / 3.733	9.49 / 7.93
	3rd (Low / High)	2.444	2.765 / 2.158	6.53 / 5.46
	4th (Low / High)	1.531	1.666 / 1.301	4.57 / 3.82
	5th (Low / High)	1.000	1.000 / 0.780	3.02 / 2.53
	6th (Low / High)	0.664	-	2.08 / 1.74
	7th (Low / High)	-	-	1.43 / 1.20
	8th (Low / High)	-	-	1.00 / 0.84
Reverse (Low / High)	6.690	8.105 / 6.327	12.92 / 10.80	
Brake	Service Brake	Full Air Brake, Drum		
	Drum Diameter	410 mm		430 mm
		Front	Φ410×156×19mm	Φ430×45mm
	Lining	Rear	Φ410×220×19mm	
		Material	Non-Asbestos	
	Parking Brake	Spring actuator at Front / Rear Wheel		
Auxiliary Brake	Exhaust Brake	Jake	Retarder	
Axle	Front	Reverse Elliot "I" Beam		
		Capacity (Kg)	6,500	8,000
	Rear	Single reduction		
		Final drive ratio	4.875	3.667
	Capacity (Kg)	11,800	13,000	
Wheel & Tire	Front	12R22.5-16PR, 22.5x8.25		315 / 70R22.5-16PR
	Rear	12R22.5-16PR, 22.5x8.25		315 / 70R22.5-16PR
Fuel Tank		RH	RH / LH	
		Side under the frame		
		STEEL 400	AL 500+300	AL 930+450
Steering	Drive Position	LHD	LHD / RHD	LHD
	Type	Recirculating ball with integral Power assisted by oil		
	Steering Cloumn	Tilt & telescopic		
	Steering Wheel	4-spoke wheel wit horn button		
Clutch	Type	Hydraulic control with air assisted Dry single plate with diaphragm spring		
	Plate Diameter	Outside Diamter : 430 mm		
Suspension	Front (mm)	Multi leaf		Parabolic
		1,500×90×13t - 7		1,900 x 100 x 32t - 2
	Rear (mm)	Multi leaf		AIR
		1,600×90× 13t - 8 / 10t -11		4-BAG
Electrical System	Batteries	PT / 12 V - 150Ah x 2		MF / 12 V - 150Ah x 2
	Alternator	24 V / 60 amp	24 V / 70 amp	24 V / 90 amp
	Starter	24 V / 5.5kw	24 V / 6.0kw	

Item		6x4 TRT		
		High / Short	High / Short	High / Medium
		D6AC	D6HB38	D6CC41
Transmission	Model	M12S2x5	H160S2x5	ZF16S1830
	Type	F12 / R2	F10 / R2	F16 / R2
	1st (Low / High)	9.153 / 7.145		13.80 / 11.54
	2nd (Low / High)	4.783 / 3.733		9.49 / 7.93
	3rd (Low / High)	2.765 / 2.158		6.53 / 5.46
	4th (Low / High)	1.666 / 1.301		4.57 / 3.82
	5th (Low / High)	1.000 / 0.780		3.02 / 2.53
	6th (Low / High)	-	-	2.08 / 1.74
	7th (Low / High)	-	-	1.43 / 1.20
	8th (Low / High)	-	-	1.00 / 0.84
Reverse (Low / High)	8.105 / 6.327		12.92 / 10.80	
Brake	Service Brake	Full Air Brake, Drum		
	Drum Diameter	410 mm		
		Front	Φ410×156×19mm	
	Lining	Rear	Φ410×220×19mm	
		Material	Non-Asbestos	
	Parking Brake	Spring actuator at Front / Rear Wheel		
Auxiliary Brake	Exhaust Brake	Jake	Retarder	
Axle	Front	Reverse Elliot "I" Beam		
		Capacity (Kg)	6,500	
	Rear	Single reduction		
		Final drive ratio	5.571	4.875
	Capacity (Kg)	13,000×2		
Wheel & Tire	Front	12R22.5-16PR, 22.5x8.25		
	Rear	12R22.5-16PR, 22.5x8.25		
Fuel Tank		RH	RH / LH	
		Side under the frame		
		STEEL 400	AL 500	AL 500+300
Steering	Drive Position	LHD	LHD / RHD	
	Type	Recirculating ball with integral Power assisted by oil		
	Steering Cloumn	Tilt & telescopic		
	Steering Wheel	4-spoke wheel wit horn button		
Clutch	Type	Hydraulic control with air assisted Dry single plate with diaphragm spring		
	Plate Diameter	Outside Diamter : 430 mm		
Suspension	Front (mm)	Multi leaf		
		1,500×90×13t - 7		
	Rear (mm)	Multi leaf		
		1,350 x 90 x 20t-3/18t-7		
Electrical System	Batteries	PT / 12 V - 150Ah x 2		
	Alternator	24 V / 60 amp	24 V / 70 amp	24 V / 90 amp
	Starter	24 V / 5.5kw	24 V / 6.0kw	

XCIENT 6x4 Dump

Item		6x4 Dump			
		15 ton	15 ton	18 ton	
		D6AC	D6HB38	D6CA41	
Dimension (mm)	Overall length	7,445		9,665	
	Overall width	2,490			
	Overall height (STD Roof)	3,540		3,635	
	Wheel Tread	Front	2,060	2,075	
		Rear	1,825	1,904	
	Wheebase	4,590		5,650	
	Frame Rear Over Hang	1,120		2,440	
	Ground to Roof (STD Roof)	3,295		3,395	
	Ground to frame (topside)	1,130		1,225	
	Cab to Rear Axle	3,000		4,060	
Weight (kg)	Kerb Weight	Front	4,590	4,680	5,025
		Rear	3,405	3,415	4,790
		Total	7,995	8,095	9,815
	Axle load	Front	7,100		8,000
		Rear	23,600		32,000
	Permissible Payload	22,705		22,605	30,185
	Permissible GVW	30,700		40,000	
Performance	Min. turning radius (m)	7		9.3	
Frame	Type	Ladder type, Single channel			
	Main Side rail	300×90×8			
Engine	Model	D6AC (Euro 1)	D6HB38 (Euro 3)	D6CA41 (Euro 4)	
	Type	Diesel,Turbo intercooler			
	Max.Power	340ps(247kw)@ 2,200 rpm	380ps(280kw)@ 2,000 rpm	410ps(302kw)@ 1,900 rpm	
	Max.Toque	140kgm(1333Nm)@ 1,400 rpm	160kgm(1568Nm)@ 1,200 rpm	188kgm(1844Nm)@ 1,500 rpm	
	No. of cylinder	In line 6 cylinder			
	Bore × Stroke	130×140 (mm)	122×142 (mm)	133×155 (mm)	
	Displacement	11,149 cc		12,920 cc	
	Controller Type	All Speed type (RLD-J)	Electronic control	Electronic control	
	Air Cleaner	Dry paper elements			

XCIENT 6x4 Cargo

Item		6x4 Cargo			
		Short	Medium	Long	
		D6AC	D6HB38	D6CC3H	
Dimension (mm)	Overall length	9,630	10,310	11,905	
	Overall width	2,490			
	Overall height (STD Roof)	3,485			
	Wheel Tread	Front	2,060		
		Rear	1,825		
	Wheebase	5,650	6,100	7,050	
	Frame Rear Over Hang	2,390	2,620	3,230	
	Ground to Roof (STD Roof)	3,240			
	Ground to frame (topside)	1,100			
	Cab to Rear Axle	4,060	4,510	5,460	
Weight (kg)	Kerb Weight	Front	4,485	4,650	4,850
		Rear	3,780	3,865	3,985
		Total	8,265	8,515	8,835
	Axle load	Front	7,100		
		Rear	23,600		
	Permissible Payload	22,435	22,185		
	Permissible GVW	30,700			
Performance	Min. turning radius (m)	8.4	9.1	10.7	
Frame	Type	Ladder type, Single channel			
	Main Side rail	300×90×8t			
Engine	Model	D6AC (Euro 1)	D6HB38 (Euro 3)	D6CC3H (Euro 4)	
	Type	Diesel,Turbo intercooler			
	Max.Power	340ps(247kw)@ 2,200 rpm	380ps(280kw)@ 2,000 rpm	380ps(280kw)@ 1,900 rpm	
	Max.Toque	140kgm(1333Nm)@ 1,400 rpm	160kgm(1568Nm)@ 1,200 rpm	160kgm(1588Nm)@ 1,200 rpm	
	No. of cylinder	In line 6 cylinder			
	Bore × Stroke	130×140 (mm)	122×142 (mm)	130×155 (mm)	
	Displacement	11,149 cc		12,344 cc	
	Controller Type	All Speed type (RLD-J)	Electronic control		
	Air Cleaner	Dry paper elements			

Item		6x4 Dump		
		15 ton	15 ton	18 ton
		D6AC	D6HB38	D6CA41
Transmission	Model	M1256	H16052x5	ZF16S1830
	Type	F6 / R1	F10 / R2	F16 / R2
	1st (Low / High)	7.213	9.153 / 7.145	13.80 / 11.54
	2nd (Low / High)	4.178	4.783 / 3.733	9.49 / 7.93
	3rd (Low / High)	2.587	2.765 / 2.158	6.53 / 5.46
	4th (Low / High)	1.621	1.666 / 1.301	4.57 / 3.82
	5th (Low / High)	1.000	1.000 / 0.780	3.02 / 2.53
	6th (Low / High)	0.702	-	2.08 / 1.74
	7th (Low / High)	-	-	1.43 / 1.20
	8th (Low / High)	-	-	1.00 / 0.84
Reverse (Low / High)	7.081	8.105 / 6.327	12.92 / 10.80	
Brake	Service Brake	Full Air Brake, Drum		
	Drum Diameter	410 mm		
	Lining	Front	Φ410×156×19mm	
		Rear	Φ410×220×19mm	
		Material	Non-Asbestos	
Parking Brake	Spring actuator at Front / Rear Wheel			
Auxiliary Brake	Exhaust Brake	Jake		
Axle	Front	Reverse Elliot "I" Beam		
		Capacity (Kg)	8,000	
	Rear	Single reduction		Tnadem HUB reduction
		Final drive ratio	6.166	5.571
Capacity (Kg)	13,000×2		16,000×2	
Wheel & Tire	Front	12R22.5-16PR, 22.5x8.25		12.00R24-18PR, 24x 8.5v
	Rear	12R22.5-16PR, 22.5x8.25		12.00R24-18PR, 24x 8.5v
Fuel Tank	Capacity (L)	RH		
		Side under the frame		
		400		
Steering	Drive Position	LHD	LHD / RHD	LHD
	Type	Recirculating ball with Power assisted by oil integral		
	Steering Cloumn	Tilt & telescopic		
	Steering Wheel	4-spoke wheel wit horn button 5-spoke wheel wit horn button 6-spoke wheel wit horn button		
Clutch	Type	Hydraulic control with air assisted Dry single plate with diaphragm spring		
	Plate Diameter	Outside Diamter : 430 mm		
Suspension	Front (mm)	Multi leaf		Multi leaf
		1,500×90×12t-4/13t-7		1,500×90×13t-11
	Rear (mm)	Multi leaf		Multi leaf
		1,350×90×20t-3/18t-8		1,350×90×22t-12
Electrical System	Batteries	PT / 12 V - 150Ah x 2		
	Alternator	24 V / 60 amp	24 V / 70 amp	24 V / 90 amp
	Starter	24 V / 5.5kw	24 V / 6.0kw	

Item		6x4 Cargo		
		Short	Medium	Long
		D6AC	D6HB38	D6CC3H
Transmission	Model	M1256	H16052x5	H16056
	Type	F6/R1	F10/R2	F6/R1
	1st (Low / High)	7.213	9.153 / 7.145	7.213
	2nd (Low / High)	4.178	4.783 / 3.733	4.178
	3rd (Low / High)	2.587	2.765 / 2.158	2.587
	4th (Low / High)	1.621	1.666 / 1.301	1.621
	5th (Low / High)	1.000	1.000 / 0.780	1.000
	6th (Low / High)	0.702	-	0.702
	7th (Low / High)	-	-	-
	8th (Low / High)	-	-	-
Reverse (Low / High)	7.081	8.105 / 6.327	7.081	
Brake	Service Brake	Full Air Brake, Drum		
	Drum Diameter	410 mm		
	Lining	Front	Φ410×156×19mm	
		Rear	Φ410×220×19mm	
		Material	Non-Asbestos	
Parking Brake	Spring actuator at Front/Rear Wheel			
Auxiliary Brake	Exhaust Brake	Jake		
Axle	Front	Reverse Elliot "I" Beam		
		Capacity (Kg)	8,000	
	Rear	Single Reduction		4.875(STD), 5.143(OPT)
		Final drive ratio	6.166(STD), 5.571(OPT)	5.571
Capacity (Kg)	11,800×2			
Wheel & Tire	Front	12R22.5-16PR, 22.5x8.25		
	Rear	12R22.5-16PR, 22.5x8.25		
Fuel Tank	Capacity (L)	RH		
		Side under the frame		
		400		
Steering	Drive Position	LHD	LHD / RHD	LHD
	Type	Recirculating ball with integral Power assisted by oil		
	Steering Cloumn	Tilt & telescopic		
	Steering Wheel	4-spoke wheel wit horn button		
Clutch	Type	Hydraulic control with air assisted Dry single plate with diaphragm spring		
	Plate Diameter	Outside Diamter : 430 mm		
Suspension	Front (mm)	Multi leaf		Multi leaf
		1,500×90×13t-9		1,500×90×13t-9
	Rear (mm)	Multi leaf		Multi leaf
		1,350×90×20t-3/18t-8		
Electrical System	Batteries	PT / 12 V - 150Ah x 2		
	Alternator	24 V / 60 amp	24 V / 70 amp	24 V / 90 amp
	Starter	24 V / 5.5kw	24 V / 6.0kw	

XCIENT 8x4 Cargo

Item		8x4 Cargo			
		Short	Extra Long	Extra Long	
		D6AC	D6HB38	D6CC41	
Dimension (mm)	Overall length	11,440	12,410	12,425	
	Overall width	2,490			
	Overall height (STD Roof)	3,490	3,485		
	Wheel Tread	Front	2,060		
		Rear	1,826		
	Wheebase	7,470	8,300		
	Frame Rear Over Hang	2,350			
	Ground to Roof (STD Roof)	3,245			
	Ground to frame (topside)	1,080			
	Cab to Rear Axle	5,880	6,710		
Weight (kg)	Kerb Weight	Front	7,295	7,410	7,590
		Rear	2,795	2,855	2,875
		Total	10,090	10,265	10,465
	Axle load	Front	13,000		
		Rear	25,200		
	Permissible Payload	28,110	27,935	27,735	
Permissible GVW	38,200				
Performance	Min. turning radius (m)	10.7	11.7		
	Frame	Type	Ladder type, Single channel		
Main Side rail		300×90×8t			
Engine	Model	D6AC (Euro 1)	D6HB38 (Euro 3)	D6CC41 (Euro 4)	
	Type	Diesel, Turbo intercooler			
	Max.Power	340ps(247kw)@ 2,200 rpm	380ps(280kw)@ 2,000 rpm	410ps(302kw)@ 1,900 rpm	
	Max.Toque	140kgm(1,333Nm)@ 1,400 rpm	160kgm(1,568Nm)@ 1,200 rpm	188kgm(1,844Nm)@ 1,200 rpm	
	No. of cylinder	In line 6 cylinder			
	Bore × Stroke	130×140 (mm)	122×142 (mm)	130×155 (mm)	
	Displacement	11,149 cc	9,960 cc	12,344 cc	
	Controller Type	All Speed type (RLD-J)	Electronic control		
	Air Cleaner	Dry paper elements			

Item		8x4 Cargo		
		Short	Extra Long	Extra Long
		D6AC	D6HB38	D6CC41
Transmission	Model	M12S2x5	H160S2x5	ZF16S1830
	Type	F6/R1	F10/R2	F16/R2
	1st (Low / High)	6.814	9.153 / 7.145	13.80 / 11.54
	2nd (Low / High)	3.947	4.783 / 3.733	9.49 / 7.93
	3rd (Low / High)	2.444	2.765 / 2.158	6.53 / 5.46
	4th (Low / High)	1.531	1.666 / 1.301	4.57 / 3.82
	5th (Low / High)	1.000	1.000 / 0.780	3.02 / 2.53
	6th (Low / High)	0.664	-	2.08 / 1.74
	7th (Low / High)	-	-	1.43 / 1.20
	8th (Low / High)	-	-	1.00 / 0.84
Reverse (Low / High)		6.690	8.105 / 6.327	12.92 / 10.80
	Service Brake	Full Air Brake, Drum		
Brake	Drum Diameter	410 mm		
	Lining	Front	Φ410×156×19mm	
		Rear	Φ410×220×19mm	
	Material	Non-Asbestos		
Parking Brake	Spring actuator at Front/Rear Wheel			
Auxiliary Brake	Exhaust Brake			
	Jake			
Axle	Front	Capacity (Kg)	Reverse Elliot "I" Beam	
			6,500×2	
	Rear	Final drive ratio	Single Reduction	
			6.166	
Capacity (Kg)	12,600×2		3.667	
	12,600×2			
Wheel & Tire	Front	12R22.5-16PR, 22.5×8.25		
	Rear	12R22.5-16PR, 22.5×8.25		
Fuel Tank		RH		
		Side under the frame		
		AL 350 → 380	STEEL 350	
Steering	Drive Position	LHD		
	Type	Recirculating ball with integral Power assisted by oil		
	Steering Cloumn	Tilt & telescopic		
Clutch	Steering Wheel	4-spoke wheel wit horn		
	Type	Hydraulic control with air assisted Dry single plate with diaphragm spring		
Suspension	Plate Diameter	Outside Diameter : 430		
	Front (mm)	Multi leaf		
		1,500×90×13t-8 (1st)		
	Rear (mm)	1,500×90×13t-8 (2nd)		
Multi leaf				
Electrical System		1,350×90×20t-3/18t-8		
	Batteries	PT / 12 V - 150Ah x 2		
	Alternator	24 V / 60 amp	24 V / 70 amp	24 V / 90 amp
Starter	24 V / 5.5kw			
		24 V / 6.0kw		

LINE-UP

Item		Tractor	Cargo	Dump	Mixer
Day Cab	Standard Roof				
Sleeper Cab	Low Roof				
	Standard Roof				
High Roof					



6x2 Tractor (standard roof)

4x2 Tractor (high roof)

6x4 Dump (standard roof)

8x4 Dump (standard roof)

6x4 Cargo (standard roof)

Mixer (standard roof)

Birth of new hero **XCIENT**



